



# Handling Compact Discs

Use only compact discs bearing the  or  mark.

Do not play heart-shaped, octagonal, or other specially shaped compact discs.

Some CDs recorded in CD-R/CD-RW mode may not be usable.

## Handling

- Compared to ordinary music CDs, CD-R and CD-RW discs are both easily affected by high temperature and humidity and some of CD-R and CD-RW discs may not be played. Therefore, do not leave them for a long time in the car.
- New discs may have some roughness around the edges. If such discs are used, the player may not work or the sound may skip. Use a ball-point pen or the like to remove any roughness from the edge of the disc.

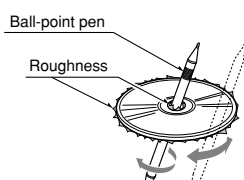

- Never stick labels on the surface of the compact disc or mark the surface with a pencil or pen.
- Never play a compact disc with any cellophane tape or other glue on it or with peeling off marks. If you try to play such a compact disc, you may not be able to get it back out of the CD player or it may damage the CD player.
- Do not use compact discs that have large scratches, are misshapen, cracked, etc. Use of such discs may cause misoperation or damage.
- To remove a compact disc from its storage case, press down on the center of the case and lift the disc out, holding it carefully by the edges.
- Do not use commercially available CD protection sheets or discs equipped with stabilizers, etc. These may damage the disc or cause breakdown of the internal mechanism.

## Storage

- Do not expose compact discs to direct sunlight or any heat source.
- Do not expose compact discs to excess humidity or dust.
- Do not expose compact discs to direct heat from heaters.

## Cleaning

- To remove fingermarks and dust, use a soft cloth and wipe in a straight line from the center of the compact disc to the circumference.
- Do not use any solvents, such as commercially available cleaners, anti-static spray, or thinner to clean compact discs.
- After using special compact disc cleaner, let the compact disc dry off well before playing it.

# 4. NOMENCLATURE

## Note:

- Be sure to read this chapter referring to the front diagrams of chapter "2. CONTROLS" on page 3 (unfold).

## Names of the Buttons and their Functions

### [ PWR ] button

- Press the button to turn on the power.  
Press and hold the button for 1 second or longer to turn off the power.
- Switches the operation mode among the radio mode, etc.

### [SCN] button

- Performs scan play for 10 seconds for each track while in the CD mode.

### [ RPT ] button

- Repeat play while in the CD mode.

### [ HOOK ]

- Open the door by push up the hook.

### [ RDM ] button

- Performs random play while in the CD mode.

### [ DOOR ]

- Door must be totally closed to prevent water go into the unit.

### [ P/A ] button

- Performs preset scan while in the radio mode.  
When the button is pressed and held, auto store is performed.

### [ D ] button

- Switches the display indication(main display, sub display, clock display).

### [ T ] button

- Use the button to input a title in the CD mode.
- Press and hold the button for 1 second or longer to enter the adjust mode.

### [ Z+ ] button

- Use the button to select one of the 3 types of sound characteristics already stored in memory.

### [ ISR ] button

- Recalls ISR radio station in memory.
- Press and hold for 2 seconds or longer: Stores current station into ISR memory (radio mode only).

### [▶/||] button

- Plays or pauses a CD while in the CD mode.

### [ DIRECT ] button

- Stores a station into memory or recall it directly while in the radio mode.

### [ BAND ] button

- Switches the band, or seek tuning or manual tuning while in the radio mode.
- Plays a first track while in the CD mode.

### [ A-M ] button

- Press and hold the button for 1 second or longer to switch the MAGNA BASS EXTEND on or off.
- Use the button to switch to the audio mode (sub woofer, bass/treble, balance/fader, Z-Enhancer plus adjustment).

### [ ▲ ], [ ▼ ] button

- Press the buttons to increases or decreases the volume.

### [ ◀ ], [ ▶ ] button

- Selects a station while in the radio mode or selects a track when listening to a CD. These buttons are also used to make various settings.
- Press and hold the button for 1 second or longer to switches the fast-forward/fast-backward.

### [ M ] button

- Turns mute on and off.

### [ CD SLOT ]

- CD insertion slot.

### [ RESET ] button

- Press and hold the button for about 2 seconds when the following symptoms occur.
  - \* Nothing happens when buttons are pressed.
  - \* Display is not accurate.

### [▲] button

- Ejects a CD when it is loaded into the unit.

# Major Button Operations when External Equipment is Connected to This Unit

## ● When the CD/MD changer is connected

\* For details, see the section “CD/MD changer operations”.

### [ SCN ] button

- Performs scan play for 10 seconds for each track. Disc scan play is performed when the button is pressed and held.

### [ RPT ] button

- Performs repeat play. When this button is pressed and held, disc repeat play is performed.

### [ RDM ] button

- Performs random play. Also performs disc random play when the button is pressed and held.

### [ DN ], [ UP ] button

- Designates the disc to be played.

### [ D ] button

- When the button is pressed and held, switches the disc titles or track titles while in the MD changer mode.
- When the button is pressed and held, switches the user titles or track titles ,etc.while in the CD changer mode.

### [ T ] button

- Use the button to input a title in the CD changer mode.
- Use the button to scroll the title during CD-text play or MD play.

### [ ▶/II ] button

- Plays or pauses a CD or MD.

### [ BAND ] button

- Disc up and plays a first track.

### [ ◀ ], [ ▶ ] button

- Selects a track when listening to a disc.

## ● When the TV is connected

\* For details, see the section “TV operations” .

### [ P/A ] button

- Performs preset scan while in the TV mode. When the button is pressed and held, auto store is performed.

### [ ▶/II ] button

- Switches the TV picture mode or VTR (external) picture mode.

### [ DIRECT ] button

- Stores a station into memory or recall it directly.

### [ BAND ] button

- Switches the band.
- When the button is pressed and held, switches seek tuning or manual mode.

### [ ◀ ], [ ▶ ] button

- Selects a station.

## ● When the Sirius Satellite Radio is connected

\* For details, refer to the Owner's Manual provided with the Sirius Satellite Radio.

### [ PWR ] button

- Press the button to switch the operation mode among the SIRIUS mode, etc.

### [ ▶/II ] button

- Performs preset scan while in the SIRIUS mode. When the button is pressed and held, auto store is performed.

### [DIRECT] button

- Stores a station into memory or recall it directly while in the SIRIUS mode.

### [ ◀ ], [ ▶ ] button

- Press the button to selects a station.

## What is Sirius Satellite Radio?



Sirius is radio the way it was meant to be: Up to 100 new channels of digital quality programming delivered to listeners coast to coast via satellite. That means 50 channels of completely commercial-free music. Plus up to 50 more channels of news, sports, and entertainment from names like CNBC, Discovery, SCI-FI Channel, A&E, House of Blues, E!, NPR, Speedvision and ESPN.

Sirius is live, dynamic entertainment, completely focused on listeners. Every minute of every day of every week will be different. All 50 commercial-free music channels are created in-house and hosted by DJs who know and love the music. Do you like Reggae? How about Classic Rock or New Rock? Sirius has an array of choices spanning a vast range of musical tastes including the hits of the 50's, 60's, 70's, & 80's as well as Jazz, Country, Blues, Pop, Rap, R&B, Bluegrass, Alternative, Classical, Heavy Metal, Dance and many others...

From its state-of-the-art, digital broadcasting facility in Rockefeller Center, New York City, Sirius will deliver the broadest, deepest mix of radio entertainment from coast to coast.

Sirius will bring you music and entertainment programming that is simply not available on traditional radio in any market across the country. It's radio like you've never heard before.

So Get Sirius and Listen Up! For more information, visit [siriusradio.com](http://siriusradio.com).

# Display Items

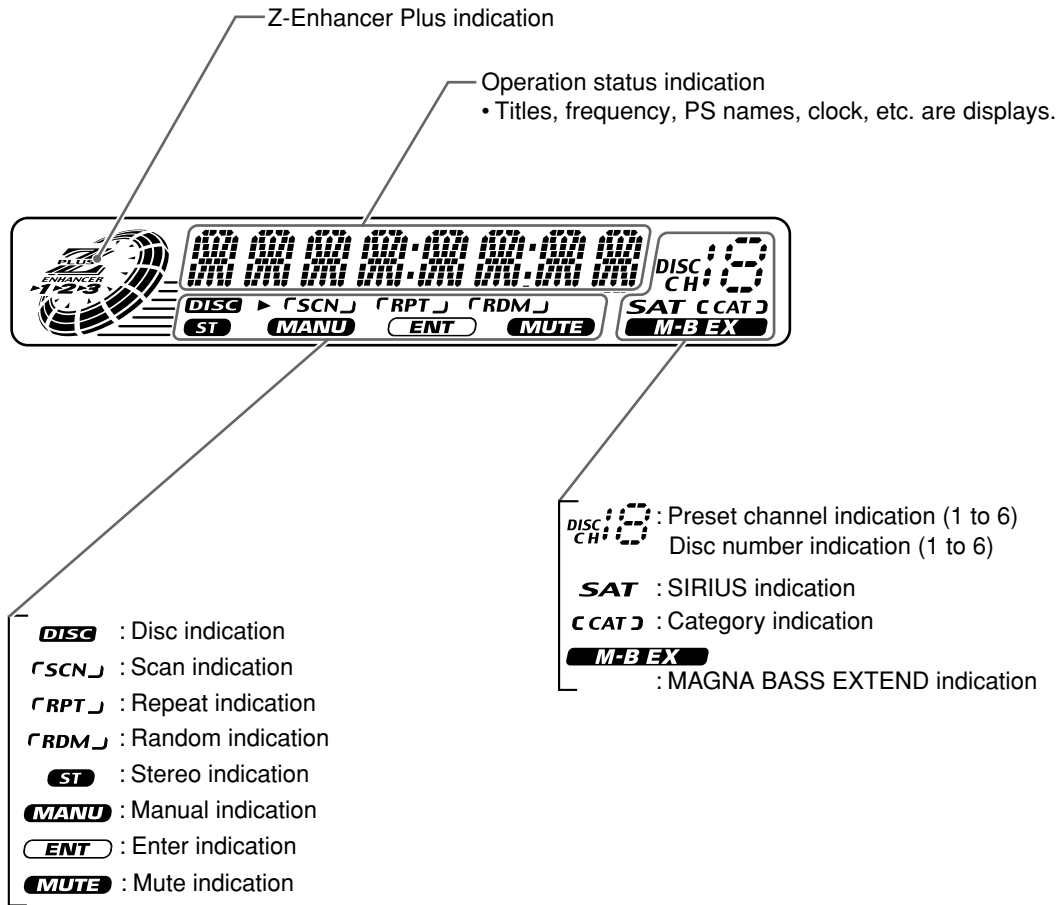

## LCD Screen

In extreme cold, the screen movement may slow down and the screen may darken, but this is normal. The screen will recover when it returns to normal temperature.

# 5. WIRED REMOTE CONTROL UNIT OPERATIONS

■ XMD3 following operations are enabled by remote control with the Wired Remote Control Unit MR301RC (sold separately).

## WIRED REMOTE CONTROL UNIT

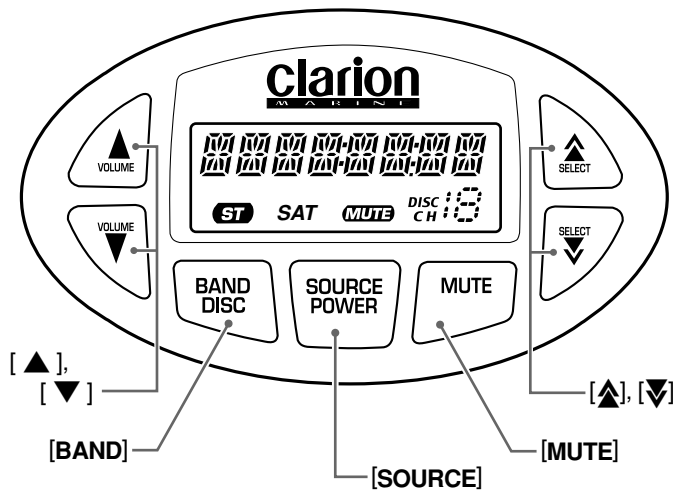

### Display Items

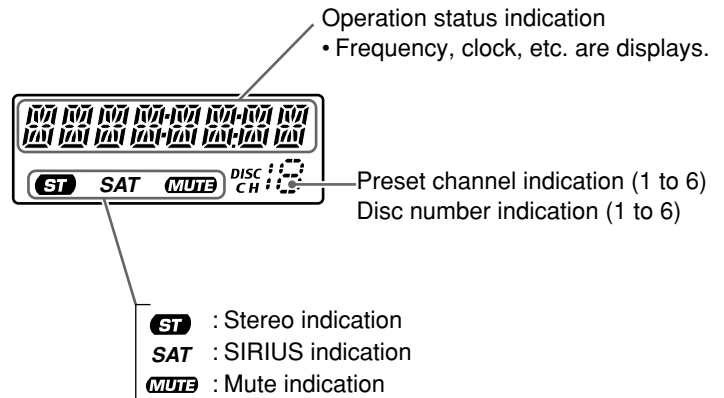

### ⚠ CAUTION

Be careful about adjusting the volume, as turning on the power while the volume is raised to its maximum may harm your hearing.

### [ SOURCE ] Button

Turning on and off the power

Press the [ SOURCE ] button to turn the power on and press and hold it for 1 second or longer to turn the power off.

### Changing the operation mode

Each time the [ SOURCE ] button is pressed, the mode switches in the following order:

Radio mode → SIRIUS mode → CD mode → CD changer mode → MD changer mode → TV mode → AUX mode → Radio mode.....

### Notes:

- If the above equipment is not connected, corresponding mode cannot be selected.
- In CD mode, if no CD is loaded in XMD3, "DISC" flashes on the Display and the radio mode is selected.

### [ ▲ ], [ ▼ ] Buttons

Adjusting the volume

Press the [ ▲ ] button to increase the volume and press the [ ▼ ] button to decrease the volume.

### [ BAND ] Button

Changing the band (in Radio mode)

Each time the [ BAND ] button is pressed, the band switches in the following order:

FM1 → FM2 → FM3 → AM → FM1.....

### Top function (in CD mode)

Press the [ BAND ] button, then the CD will start from the first song (track number 1).

### Changing the disc (in changer mode)

Each time the [ BAND ] button is pressed, the disc switches in the following order:

1 → 2 → 3 → 4 → 5 → 6 → 1.....

### [ MUTE ] Button

Press the [ MUTE ] button. The sound is muted immediately.

To cancel, press the [ MUTE ] button again.

### [ ▲ ], [ ▼ ] Buttons

Selecting tracks (in changer mode or CD mode)

Press the [ ▲ ] button to start playback from the beginning of the following track. Press the [ ▼ ] button to start playback from the beginning of the current track. If pressed again, the track moves to the previous one.

### Fast-forward and fast-backward (in changer mode or CD mode)

Press and hold the [ ▲ ] button to fast-forward the disc. Press and hold the [ ▼ ] button to fast-backward the disc.

\* Pressing and holding the [ ▲ ] or [ ▼ ] buttons for 1 second or longer will move forward or backward 3 times faster than normal play, and pressing and holding it for 3 seconds or longer will do the operation 30 times faster.

### Changing preset stations (in Radio mode)

Each time the [ ▲ ] or [ ▼ ] buttons are pressed, the preset station switches in the following order:

1 → 2 → 3 → 4 → 5 → 6 → 1.....

or

6 → 5 → 4 → 3 → 2 → 1 → 6.....

# 6. OPERATIONS

## Basic Operations

**Note:** Be sure to read this chapter referring to the front diagrams of chapter "2. CONTROLS" on page 3 (unfold).

### ⚠ CAUTION

When this unit is turned on, starting and stopping the engine of a boat with its volume raised to the maximum level may harm your hearing.

Be careful about adjusting the volume.

### IMPORTANT

Door must be totally closed to prevent water go into the set!

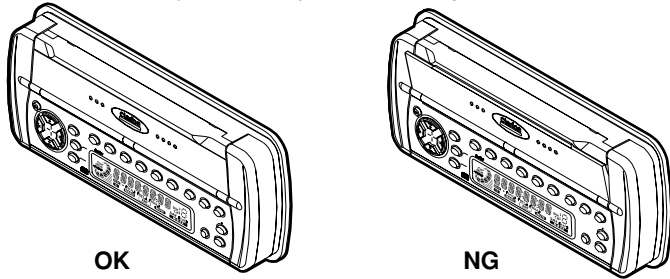

### Turning on/off the power

1. Press the [ PWR ] button.
2. The illumination and display on the unit light up. The unit automatically remembers its last operation mode and will automatically switch to display that mode.
3. Press and hold the [ PWR ] button for 1 second or longer to turn off the power for the unit.

#### Note:

##### • System check

The first time this unit is turned on after the wire connections are completed, it must check what equipment is connected. When the power is turned on, "SYSTEM" and "PUSH PWR" appear in the display alternately, so press the [ PWR ] button. The system check starts within the unit. When the system check is complete, the power is turned off, so press the [ PWR ] button again.

### Selecting a mode

1. Press the [ PWR ] button to change the operation mode.
2. Each time you press the [ PWR ] button, the operation mode changes in the following order:  
Radio mode → SIRIUS mode → CD mode → CD changer mode → MD changer mode → TV tuner → AUX mode → Radio mode...  
\* External equipment not connected with CeNET is not displayed.

### Adjusting the volume

Press the [ ▲ ] or [ ▼ ] button increases or decreases the volume.

\* The volume level is from 0 (minimum) to 33 (maximum).

### Switching the Display

Press the [ D ] button to select the desired display.

Each time you press the [ D ] button, the display switches in the following order:

Main display



Sub (title) display



Clock display



Main display

\* Once selected, the preferred display becomes the display default. When a function adjustment such as volume is made, the screen will momentarily switch to that function's display, then revert back to the preferred display several seconds after the adjustment.

\* When you have entered a title in a CD, it appears in the sub display. If you have not entered a title, "NO TITLE" appears in the title display instead. For information on how to enter a title, refer to the subsection "Entering titles" in section "Operations Common to Each Mode".

### Setting the Z-Enhancer Plus

This unit are provided with 3 types of sound tone effects stored in memory. Select the one you prefer.

\* The factory default setting is "Z+ OFF".

Each time you press the [ Z+ ] button, the tone effect changes in the following order:

"Z+ OFF" → "B-BOOST" → "IMPACT" → "EXCITE" → "CUSTOM" → "Z+ OFF" ...

- B-BOOST : bass emphasized
- IMPACT : bass and treble emphasized
- EXCITE : bass and treble emphasized mid de-emphasized
- CUSTOM : user custom
- Z+ OFF : no sound effect

### Adjusting the tone

Press the [ A-M ] button and select the item to adjust. Each time you press the [ A-M ] button, the item changes in the following order:

- When "B-BOOST" is set  
"S-VOL 0" → "B-BOOST" → "BAL 0" → "FAD 0" → Last function mode.
- When "IMPACT" is set  
"S-VOL 0" → "IMPACT" → "BAL 0" → "FAD 0" → Last function mode.
- When "EXCITE" is set  
"S-VOL 0" → "EXCITE" → "BAL 0" → "FAD 0" → Last function mode.
- When "CUSTOM" is set  
"S-VOL 0" → "BASS" → "TREBLE" → "BAL 0" → "FAD 0" → Last function mode.
- When "Z+ OFF" is set  
"S-VOL 0" → "BAL 0" → "FAD 0" → Last function mode.  
\* If sub-woofer is effective, "S-VOL 0" can be selected.

## Adjusting the subwoofer

When you default select one of mode (LPF50, LPF80, LPF120)

\* The factory default setting is "S-VOL 0". (Adjustment range: -6 to +6)

1. Press the [ **A-M** ] button and select "S-VOL 0".
2. Press the [ ▲ ] or [ ▼ ] button increases or decreases the subwoofer volume.  
Press and hold the [ ▲ ] or [ ▼ ] button automatically increases or decreases the subwoofer volume.
3. When the adjustment is complete, press the [ **A-M** ] button several times until the function mode is reached.

## Adjusting the bass (Gain, Frequency, Q-curve)

This adjustment can be performed when the Z-Enhancer Plus is set to "CUSTOM".

1. Press the [ **A-M** ] button and select "BASS".
2. Press the [ ▲ ] button emphasizes the bass.  
Press the [ ▼ ] button attenuates the bass.  
\* The factory default setting is "B<G 0>". (Adjustment range: -6 to +6)
3. Press the [ ►► ] or [ ◀◀ ] button to select "B<F 60>".  
Press the [ ▲ ] or [ ▼ ] button to select the frequency.  
\* The factory default setting is "B<F 60>". (Adjustment 60/100/200 Hz)
4. Press the [ ►► ] or [ ◀◀ ] button to select "B<Q 1>".  
Press the [ ▲ ] or [ ▼ ] button to select the Q-curve.  
\* The factory default setting is "B<Q 1>". (Adjustment 1/1.25/1.5/2)
5. When the adjustment is complete, press the [ **A-M** ] button several times until the function mode is reached.

## Adjusting the treble (Gain, Frequency)

This adjustment can be performed when the Z-Enhancer Plus is set to "CUSTOM".

1. Press the [ **A-M** ] button and select "TREBLE".
2. Press the [ ▲ ] button emphasizes the treble.  
Press the [ ▼ ] button attenuates the treble.  
\* The factory default setting is "T<G 0>". (Adjustment range: -6 to +6)
3. Press the [ ►► ] or [ ◀◀ ] button to select "T<F 10>".  
Press the [ ▲ ] or [ ▼ ] button to select the frequency.  
\* The factory default setting is "T<F 10>". (Adjustment 10 kHz/15 kHz)
4. When the adjustment is complete, press the [ **A-M** ] button several times until the function mode is reached.

## Adjusting the balance

1. Press the [ **A-M** ] button and select "BAL 0".
2. Press the [ ▲ ] button emphasizes the sound from the right speaker, press the [ ▼ ] button emphasizes the sound from the left speaker.  
\* The factory default setting is "BAL 0". (Adjustment range: L13 to R13)
3. When the adjustment is complete, press the [ **A-M** ] button several times until the function mode is reached.

## Adjusting the fader

1. Press the [ **A-M** ] button and select "FAD 0".
2. Press the [ ▲ ] button emphasizes the sound from the front speaker, press the [ ▼ ] button emphasizes the sound from the rear speaker.  
\* The factory default setting is "FAD 0". (Adjustment range: F12 to R12)
3. When the adjustment is complete, press the [ **A-M** ] button several times until the function mode is reached.

## Adjusting the Z-Enhancer Plus

1. Press the [ **Z+** ] button and select the Z-Enhancer Plus mode to adjust.
2. Press the [ **A-M** ] button and press the [ ▲ ] button adjusts in the + direction; press the [ ▼ ] button adjusts in the - direction.
  - When "B-BST 0" is selected, you can adjust the bass in the range of -3 to 3.
  - When "IMPACT 0" is selected, you can adjust the bass and treble in the range of -3 to 3.
  - When "EXCITE 0" is selected, you can adjust the bass and treble in the range of -3 to 3.

\* Press and hold the [ **Z+** ] button for 2 seconds or longer to change to the "CUSTOM" mode.  
Bass/treble characteristics become flat and the indication "Z+FLAT" is shown in the display.  
Press the [ **Z+** ] button again to change to the "Z+ OFF" mode.

## Turning on/off MAGNA BASS EXTEND

The MAGNA BASS EXTEND does not adjust the low sound area like the normal sound adjustment function, but emphasizes the deep bass sound area to provide you with a dynamic sound.

\* The factory default setting is off.

1. Press and hold the [ **A-M** ] button for 1 second or longer to turn on the MAGNA BASS EXTEND effect. "M-B EX" lights in the display.
2. Press and hold the [ **A-M** ] button for 1 second or longer to turn off the MAGNA BASS EXTEND effect. "M-B EX" goes off from the display.

## FM reception

For enhanced FM performance the **MAGITUNE3**® tuner includes signal actuated stereo control, Enhanced Multi AGC, Impulse noise reduction circuits and Multipath noise reduction circuits.

## Changing the reception area

This unit is initially set to USA frequency intervals of 10kHz for AM and 200kHz for FM. When using it outside the USA, the frequency reception range can be switched to the intervals below.

		U.S. standard (Initial setting)	Europe standard	Other countries
AM	Frequency spacing	10 kHz	9 kHz	9 kHz
	Frequency range	530 to 1,710 kHz	531 to 1,602 kHz	531 to 1,629 kHz
FM	Frequency spacing	200 kHz	Seek:100 kHz Manual:50kHz	50 kHz
	Frequency range	87.9 to 107.9 MHz	87.5 to 108 MHz	87.0 to 108 MHz

### Setting the reception area

\* Any station preset memories are lost when the reception area is changed.

1. Press the [ **BAND** ] button and select the desired radio band (FM or AM).

#### • U.S. standard (initial setting)

- 2-1. While pressing the [ **A-M** ] button, press and hold the number "1" of the [ **DIRECT** ] buttons for 2 seconds or longer.

#### • Europe standard (new setting)

- 2-1. While pressing the [ **A-M** ] button, press and hold the number "3" of the [ **DIRECT** ] buttons for 2 seconds or longer.

#### • Other countries (new setting)

- 2-1. While pressing the [ **A-M** ] button, press and hold the number "2" of the [ **DIRECT** ] buttons for 2 seconds or longer.

## Listening to the radio

1. Press the [ **PWR** ] button and select the radio mode. The frequency or PS appears in the display.  
\* PS: Programme service name
2. Press the [ **BAND** ] button and select the radio band. Each time the button is pressed, the radio reception band changes in the following order:  
FM1 → FM2 → FM3 → AM → FM1...
3. Press the [ **◀** ] or [ **▶** ] button to tune in the desired station.

## Mute

Use this function to turn off the sound immediately.

1. Press the [ **M** ] button.  
The sound turns off and "MUTE" appears in the display.
2. Press the [ **M** ] button again to cancel the mute mode.

## Tuning

There are 3 types of tuning mode available, seek tuning, manual tuning and preset tuning.

## Seek tuning

1. Press the [ **BAND** ] button and select the desired band (FM or AM).  
\* If "MANU" is lit in the display, press and hold the [ **BAND** ] button for 1 second or longer. "MANU" in the display goes off and seek tuning is now available.
2. Press the [ **◀** ] or [ **▶** ] button to automatically seek a station. When the [ **▶** ] button is pressed, the station is sought in the direction of higher frequencies; if the [ **◀** ] button is pressed, the station is sought in the direction of lower frequencies.

## Manual tuning

There are 2 ways available: Quick tuning and step tuning.

When you are in the step tuning mode, the frequency changes one step at a time. In the quick tuning mode, you can quickly tune the desired frequency.

1. Press the [ **BAND** ] button and select the desired band (FM or AM).  
\* If "MANU" is not lit in the display, press and hold the [ **BAND** ] button for 1 second or longer. "MANU" is lit in the display and manual tuning is now available.
2. Tune in a station.

#### ● Quick tuning:

Press and hold the [ **◀** ] or [ **▶** ] button for 1 second or longer to tune in a station.

#### ● Step tuning:

Press the [ **◀** ] or [ **▶** ] button to manually tune in a station.

## Recalling a preset station

A total of 24 preset positions (6-FM1, 6-FM2, 6-FM3, 6-AM) exist to store individual radio stations in memory. Pressing the corresponding [ **DIRECT** ] button recalls the stored radio frequency automatically.

1. Press the [ **BAND** ] button and select the desired band (FM or AM).
2. Press the corresponding [ **DIRECT** ] button to recall the stored station.  
\* Press and hold one of the [ **DIRECT** ] buttons for 2 seconds or longer to store that station into preset memory.

## Manual memory

1. Select the desired station with seek tuning, manual tuning or preset tuning.
2. Press and hold one of the [ **DIRECT** ] buttons for 2 seconds or longer to store the current station into preset memory.

## Auto store

Auto store is a function for storing up to 6 stations that are automatically tuned in sequentially. If 6 receivable stations cannot be received, a previously stored station remains unoverwritten at the memory position.

1. Press the [ **BAND** ] button and select the desired band (FM or AM).
2. Press and hold the [ **P/A** ] button for 2 seconds or longer. The stations with good reception are stored automatically to the preset channels.  
\* If auto store is performed in the FM bands, the stations are stored in FM3 even if FM1 or FM2 was chosen for storing stations.



## Preset scan

Preset scan receives the stations stored in preset memory in order. This function is useful when searching for a desired station in memory.

1. Press the [ P/A ] button.
2. When a desired station is tuned in, press the [ P/A ] button again to continue receiving that station.

### Note:

- Be careful not to press and hold the [ P/A ] button for 2 seconds or longer, otherwise the auto store function is engaged and the unit starts storing stations.

## Instant station recall (ISR)

Instant station recall is a special radio preset that instantly accesses a favorite radio station at a touch of a button. The ISR function even operates with the unit in other modes.

### ● ISR memory

1. Select the station that you wish to store in ISR memory.
2. Press and hold the [ ISR ] button for 2 seconds or longer.

### ● Recalling a station with ISR

In any mode, press the [ ISR ] button to turn on the radio function and tune the selected radio station. "ISR" appears in the display. Press the [ ISR ] button again to return to the previous mode.

## Loading a CD



1. Open the door by push up the [ HOOK ].
2. Insert a CD into the centre of the [ CD SLOT ] with the label side facing up, and completely close the [ DOOR ].  
The CD plays automatically after loading.

For 5-inch (12 cm) CD

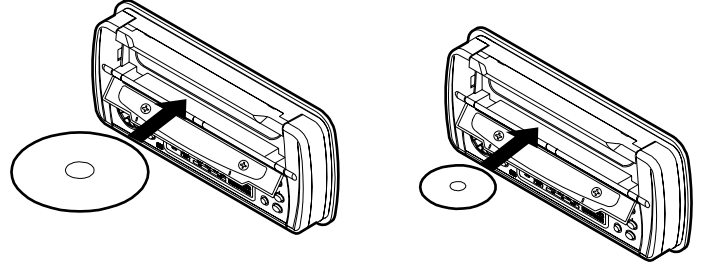
For 3-inch (8 cm) single CD



### Notes:

- Never insert foreign objects into the CD SLOT.
- If the CD is not inserted easily, there may be another CD in the mechanism or the unit may require service.
- Discs not bearing the  or  mark and CD-ROMs cannot be played by this unit.
- Some CDs recorded in CD-R/CD-RW mode may not be usable.

### Loading 8 cm compact discs

- \* No adapter is required to play an 8 cm CD.
- \* Insert the 8 cm CD into the centre of the insertion slot.

### Listening to a CD already inserted

Press the [ PWR ] button to select the CD mode. Play starts automatically. If no CD is loaded in the unit, "NO DISC" appears in the display.

## Pausing play

1. Press the [ ▶/II ] button to pause play. "PAUSE" appears in the display.
2. To resume CD play, press the [ ▶/II ] button again.

## Displaying CD titles

This unit can display title data for CD-text CDs and user titles input with this unit.

1. Press the [ D ] button to display the title.
2. Each time you press and hold the [ D ] button for 1 second or longer, the title display changes in the following order:  
User title (disc) → CD-text title (disc) → Artist name → CD-text title (track) → User title (disc)...

### Note:

- If the CD playing is not a CD-text CD or no user title has been input, "NO TITLE" appears in the display.

## Ejecting a CD

1. Open the door by push up the [ HOOK ].
2. Press the [ ▲ ] to eject the CD. Take it out from the ejected position.

### Notes:

- If a CD (12 cm) is left in the ejected position for 15 seconds, the CD is automatically reloaded (Auto reload).
- 8 cm CDs are not auto reloaded. Be sure to remove it when ejected.
- If you force a CD into before auto reloading, this can damage the CD.

## Selecting a track

### ● Track-up

1. Press the [ **▶▶** ] button to move ahead to the beginning of the next track.
2. Each time you press the [ **▶▶** ] button, the track advances ahead to the beginning of the next track.

### ● Track-down

1. Press the [ **◀◀** ] button to move back to the beginning of the current track.
2. Press the [ **◀◀** ] button twice to move to the beginning of the previous track.

## Fast-forward/fast-backward

### ● Fast-forward

Press and hold the [ **▶▶** ] button for 1 second or longer.

### ● Fast-backward

Press and hold the [ **◀◀** ] button for 1 second or longer.

## Top function

The top function resets the CD player to the first track of the disc. Press the [ **BAND** ] button to play the first track (track No. 1) on the disc.

## Scan play

The scan play locates and plays the first 10 seconds of each track on a disc automatically. This function continues on the disc until it is cancelled.

\* The scan play is useful when you want to select a desired track.

1. Press the [ **SCN** ] button to start scan play. "SCN" lights in the display.
2. To cancel the scan play, press the [ **SCN** ] button again. "SCN" goes off from the display and the current track continues to play.

## Repeat play

The repeat play continuously plays the current track. This function continues automatically until it is cancelled.

1. Press the [ **RPT** ] button. "RPT" lights in the display and the current track is repeated.
2. To cancel the repeat play, press the [ **RPT** ] button again. "RPT" goes off from the display and normal play resumes.

## Random play

The random play selects and plays individual tracks on a disc in no particular order. This function continues automatically until it is cancelled.

1. Press the [ **RDM** ] button. "RDM" lights in the display, an individual track is selected randomly and play begins.
2. To cancel the random play, press the [ **RDM** ] button again. "RDM" goes off from the display and normal play resumes.

## Operations Common to Each Mode

### Entering titles

Titles up to 8 characters long can be stored in memory and displayed for CD, CD changer and TV stations. The number of titles that can be entered for each mode are as follows.

Mode	Number of titles
CD mode	50 titles
TV mode	20 titles

CD changer mode	Number of titles
CDC625 connected	100 titles
CDC655Tz connected	100 titles
CDC1255z connected	50 titles

1. Press the [ **PWR** ] button to select the mode you want to enter a title (CD, CD changer or TV).
2. Select and play a CD in the CD changer or tune in to a TV station for which you want to enter the title.
3. Press the [ **D** ] button and display the sub.
4. Press the [ **T** ] button. The cursor position flashes.
5. Press the [ **◀◀** ] or [ **▶▶** ] button to move the cursor.
6. Press the [ **D** ] button to select a character. Each time you press the [ **D** ] button, the character changes in the following order:  
Numbers → Symbols → Capital letters → Numbers...
7. Press the [ **▲** ] or [ **▼** ] button to select the desired character.  
Press the [ **◀◀** ] button moves the cursor to the next character;  
Press the [ **▶▶** ] button moves the cursor to the previous character.
8. Repeat steps 5 to 7 to enter up to 8 characters for the title.
9. Press and hold the [ **▶/II** ] button for 2 seconds or longer to store the title into memory and cancel title input mode.

### Clearing titles

1. Select and play a CD in the CD changer or tune in to a TV station for which you want to clear the title.
2. Press the [ **D** ] button and display the sub.
3. Press the [ **T** ] button. Titles appears in the display and the display switches to the title input display.
4. Press the [ **BAND** ] button.
5. Press and hold the [ **▶/II** ] button for 2 seconds or longer to clear the title and cancel title input mode.

### Setting the low pass filter

This function allows you to set the low-pass filter for sub-woofer output.

\* The factory default setting is "LPF 120".

1. Press and hold the [ **T** ] button for 1 second or longer to switch to the adjustment selection display.
2. Press the [ **◀◀** ] or [ **▶▶** ] button and select "SW LPF".
3. Press the [ **▲** ] or [ **▼** ] button to setting changes as following order:  
"LPF 120" ↔ "LPF 80" ↔ "LPF 50" ↔ "REAR"
4. Press the [ **T** ] button to return to the previous mode.

### Dimmer control

You can setting the dimmer control on or off.

\* The factory default setting is "ON".

1. Press and hold the [ T ] button for 1 second or longer to switch to the adjustment selection display.
2. Press the [ ◀ ] or [ ▶ ] button to select "DIMMER".
3. Press the [ ▲ ] or [ ▼ ] button to select "ON" or "OFF".
4. Press the [ T ] button to return to the previous mode.

### Adjusting the display contrast

You can adjust the display contrast to match the angle of installation of the unit.

\* The factory default setting is "5". (Adjustment level 1 to 8)

1. Press and hold the [ T ] button for 1 second or longer to switch to the adjustment selection display.
2. Press the [ ◀ ] or [ ▶ ] button and select "CONTRAST".
3. Press the [ ▲ ] or [ ▼ ] button to adjust the contrast.
4. Press the [ T ] button to return to the previous mode.

### Setting the method for title scroll

Set how to scroll in CD-TEXT or MD.

\* The factory default setting is "ON".

1. Press and hold the [ T ] button for 1 second or longer to switch to the adjustment selection display.
2. Press the [ ◀ ] or [ ▶ ] button and select "SCROLL".
3. Press the [ ▲ ] or [ ▼ ] button to select "ON" or "OFF".
  - ON : To scroll automatically.
  - OFF : To scroll just 1 time when the title was changed or the title key was pressed.
4. Press the [ T ] button to return to the previous mode.

### AUX function

This system has an external RCA input so you can listen to sounds and music from external devices connected to this unit.

### Selecting AUX IN sensitivity

Make the following settings to select the sensitivity when sounds from external devices connected to this unit are difficult to hear even after adjusting the volume.

\* The factory default setting is "MID".

1. Press and hold the [ T ] button for 1 second or longer to switch to the adjustment selection display.
2. Press the [ ◀ ] or [ ▶ ] button and select "AUX SENS".
3. Press the [ ▲ ] or [ ▼ ] button needed and select from "HIGH (high)", "MID (middle)" or "LOW (low)".
4. Press the [ T ] button to return to the previous mode.

### Setting the clock

1. Press and hold the [ T ] button for 1 second or longer to switch to the adjustment selection display.
2. Press the [ ◀ ] or [ ▶ ] button to select "CLOCK".
3. Press the [ ▶/II ] button.
4. Press the [ ◀ ] or [ ▶ ] button to select the hour or the minute.
5. Press the [ ▲ ] or [ ▼ ] button to set the correct time.

\* The clock is displayed in 12-hour format.

6. Press the [ ▶/II ] button to store the time into memory.
7. Press the [ T ] button to return to the previous mode.

#### Note:

- You cannot set the clock when it is displayed with only the ignition on. If you drain or remove the car's battery or take out this unit, the clock is reset. While setting the clock, if another button or operation is selected, the clock set mode is canceled.

### Turning the screen saver function on or off

This unit is provided with the screen saver function. You can turn on or off this function.

If the button operation is performed with the screen saver function on, the operation display corresponding to the button operation is shown for about 30 seconds and the display returns to the screen saver display.

\* The factory default setting is "SS".

1. Press and hold the [ T ] button for 1 second or longer to switch to the adjustment selection display.
2. Press the [ ◀ ] or [ ▶ ] button and select "SCRN SVR".
3. Press the [ ▶/II ] button.
4. Press the [ ▲ ] or [ ▼ ] button to setting changes as following order:

"MESSAGE" ↔ "SS"(screen saver) ↔ "OFF (off)"

5. Press the [ ▶/II ] button to store the setting.
6. Press the [ T ] button to return to the previous mode.

\* The following illustration presents one of the patterns which are shown when the screen saver function is turned on.



### Entering message information

Message up to 30 characters long can stored in memory and display for any mode.

Any of the messages input can be displayed as one of the patterns for the screen saver function.

\* The factory default setting is "WELCOME TO CLARION".

1. Press and hold the [ T ] button for 1 second or longer to switch to the adjustment selection display.
2. Press the [ ◀ ] or [ ▶ ] button and select "INPUT".
3. Press the [ ▶/II ] button.
4. Press the [ ◀ ] or [ ▶ ] button to move the cursor.
5. Press the [ D ] button to select a character. Each time you press the [ D ] button, the character changes in the following order: Numbers → Symbols → Capital letters → Numbers...
6. Press the [ ▲ ] or [ ▼ ] button to select the desired character. Press the [ ▶ ] button moves the cursor to the next character; Pressing the [ ◀ ] button moves the cursor to the previous character.
7. Repeat steps 4 to 6 to enter up to 30 characters for the message.
8. Press and hold the [ ▶/II ] button for 2 seconds or longer to store the message into memory and cancel message input mode.
9. Press the [ T ] button to return to the previous mode.

# 7. OPERATIONS OF ACCESSORIES

## CD/MD Changer Operations

### CD/MD changer functions

When an optional CD/MD changer is connected through the CeNET cable, this unit controls all CD/MD changer functions. This unit can control a total of 2 changers (MD and/or CD).

Press the [ **PWR** ] button and select the CD(MD) changer mode to start play. If 2 CD(MD) changers are connected, press the [ **PWR** ] button to select the CD(MD) changer for play.

\* If “**NO MAG**” appears in the display, insert the magazine into the CD changer. “**DISC CHK**” appears in the display while the player loads (checks) the magazine.

\* If “**NO DISC**” appears in the display, eject the magazine and insert discs into each slot. Then, reinsert the magazine back into the CD changer.

\* If “**NO DISC**” appears in the display, load MDs into the MD changer.

### ▲ CAUTION

CD-ROM discs cannot be played in the CD changer.

### Pausing play

1. Press the [ **▶/||** ] button to pause play. “**PAUSE**” appears in the display.
2. To resume play, press the [ **▶/||** ] button again.

### Displaying CD titles

This unit can display title data for CD-text CDs and user titles input with this unit.

\* Title data for CD-text CDs can be displayed with this unit only when it is connected to CDC655Tz.

#### ● When connected to DCZ625 or CDC1255z

1. Press the [ **D** ] button to display the title.

#### ● When connected to CDC655Tz

1. Press the [ **D** ] button to display the title.
2. Each time you press and hold the [ **D** ] button for 1 second or longer, the title display changes in the following order:  
User title (disc) → CD-text title (disc) → Artist name → CD-text title (track) → User title (disc)...

#### Notes:

- If the CD playing is not a CD-text CD or no user title has been input, “**NO TITLE**” appears in the display.
- If a CD-text CD is not input its disc title or a track title, “**NO TITLE**” appears in the display.

### Switching disc titles and track titles(MD)

This unit can display disc titles and track titles already entered on MDs.

\* Titles cannot be entered for MDs with this unit.

1. Press the [ **D** ] button to display the title. The disc title or track title is displayed.
2. Each time you press and hold the [ **D** ] button for 1 second or longer, the display toggles between the disc title and the track title.

#### Note:

- If an MD is not input its disc title or a track title, “**NO TITLE**” appears in the display.

### Procedure to scroll a title

Set “**SCROLL**” to “**ON**” or “**OFF**”.

(The factory default setting is “**ON**”. Refer to the subsection “**Setting the method for Title scroll**” in section “**Operation common to each mode**”.)

#### ● When set to “ON”

The title is automatically kept scrolling.

#### ● When set to “OFF”

To scroll just 1 time when the title was changed or the [ **T** ] button was pressed.

### Selecting a CD or MD

1. Press the [ **UP** ] or [ **DN** ] button to select the desired disc.
  - \* If a CD is not loaded in a slot of magazine, pressing the [ **UP** ] or [ **DN** ] button can not work.
  - \* If an MD is not loaded in a slot of MD changer, pressing the [ **UP** ] or [ **DN** ] button can not work.

### Selecting a track

#### ● Track-up

1. Press the [ **▶▶** ] button to move ahead to the beginning of the next track.
2. Each time you press the [ **▶▶** ] button, the track advances ahead to the beginning of the next track.

#### ● Track-down

1. Press the [ **◀◀** ] button to move back to the beginning of the current track.
2. Press the [ **◀◀** ] button twice to move to the beginning of the previous track.

### Fast-forward/fast-backward

#### ● Fast-forward

Press and hold the [ **▶▶** ] button for 1 second or longer.

#### ● Fast-backward

Press and hold the [ **◀◀** ] button for 1 second or longer.

### Scan play

Scan play locates and plays the first 10 seconds of each track on a disc automatically. This function continues on the disc until it is cancelled.

\* The scan play is useful when you want to select a desired track.

1. Press the [ **SCN** ] button to start track scanning. “**SCN**” lights in the display.
2. To cancel the scan play, press the [ **SCN** ] button again. “**SCN**” goes off from the display and the current track continues to play.

### Disc scan play

Disc scan play locates and plays the first 10 seconds of the first track on each disc in the currently selected CD (MD) changer. This function continues automatically until it is cancelled.

\* Disc scan play is useful when you want to select a desired CD (MD).

1. Press and hold the [ **SCN** ] button for 1 second or longer. “**DISC**” and “**SCN**” light in the display and disc scan play starts.

2. To cancel disc scan play, press the [ **SCN** ] button again. "DISC" and "SCN" go off from the display and the current track continues to play.

### Repeat play

Repeat play continuously plays the current track. This function continues automatically until it is cancelled.

1. Press the [ **RPT** ] button. "RPT" lights in the display and the current track is repeated.
2. To cancel repeat play, press the [ **RPT** ] button again. "RPT" goes off from the display and normal play resumes.

### Disc repeat play

After all the tracks on the current disc have been played, disc repeat play automatically replays the current disc over from the first track. This function continues automatically until it is cancelled.

1. Press and hold the [ **RPT** ] button for 1 second or longer. "DISC" and "RPT" light in the display and disc repeat play starts.
2. To cancel disc repeat play, press and hold the [ **RPT** ] button again. "DISC" and "RPT" go off from the display and normal play resumes on the current track.

### Random play

Random play selects and plays individual tracks on the disc in no particular order. This function continues automatically until it is cancelled.

1. Press the [ **RDM** ] button. "RDM" lights in the display and random play begins.
2. To cancel random play, press the [ **RDM** ] button again. "RDM" goes off from the display and normal play resumes.

### Disc random play

The disc random play selects and plays individual tracks or discs automatically in no particular order. This function continues automatically until it is cancelled.

1. Press and hold the [ **RDM** ] button for 1 second or longer. "DISC" and "RDM" light in the display and disc random play starts.
2. To cancel disc random play, press and hold the [ **RDM** ] button again. "DISC" and "RDM" go off from the display and normal play resumes from the current track.

### TV tuner functions

When an optional TV tuner is connected through the CeNET cable, this unit controls all TV tuner functions. To watch TV requires a TV tuner and monitor.

### Watching a TV

1. Press the [ **PWR** ] button and select the TV mode.
2. Press the [ **BAND** ] button to select the desired TV band (TV1 or TV2). Each time the button is pressed, the input selection toggles between TV1 and TV2.
3. Press the [ **◀** ] or [ **▶** ] button to tune in the desired TV station.

### Watching a video

The TV tuner has a VTR input terminal to which 1 external device can be connected. Connect a 12 V video cassette player (VCP) or video cassette recorder (VCR) to the TV tuner input terminal.

1. Press the [ **▶/II** ] button to select VTR.
2. To return to the TV broadcast, press the [ **▶/II** ] button.

### Tuning

There are 3 types of tuning mode available, Seek tuning, manual tuning and preset tuning.

### Seek tuning

1. Press the [ **BAND** ] button and select the desired TV band (TV1 or TV2).
  - \* If "MANU" is lit in the display, press and hold the [ **BAND** ] button for 1 second or longer. "MANU" in the display goes off and seek tuning is now available.
2. Press the [ **◀** ] or [ **▶** ] button to automatically seek a station. Press the [ **▶** ] button to automatically tune up the frequency band to the next available TV station; press the [ **◀** ] button to automatically tune down.

### Manual tuning

There are 2 ways available: Quick tuning and step tuning.

When you are in the step tuning mode, the frequency changes one step at a time. In the quick tuning mode, you can quickly tune the desired frequency.

1. Press the [ **BAND** ] button and select the desired band (TV1 or TV2).
  - \* If "MANU" is not lit in the display, press and hold the [ **BAND** ] button for 1 second or longer. "MANU" lights in the display and manual tuning is now available.
2. Tune in a station.
  - **Quick tuning:**  
Press and hold the [ **◀** ] or [ **▶** ] button for 1 second or longer to tune in a station.
  - **Step tuning:**  
Press the [ **◀** ] or [ **▶** ] button to manually tune in a station.

### Recalling a preset station

A total of 12 TV stations can be stored (6-TV1 and 6-TV2). This allows you to select your favorite TV stations and store them in memory for later recall.

1. Press the [ **BAND** ] button and select the desired TV band (TV1 or TV2).
2. To recall a stored TV station, press the desired [ **DIRECT** ] button to select that station.
  - \* Press and hold one of the [ **DIRECT** ] buttons for 2 seconds or longer to store the current station into preset memory.

### Manual memory

1. Select the desired station with seek tuning, manual tuning or preset tuning.
2. Press and hold one of [ **DIRECT** ] buttons for 2 seconds or longer to store the current station into preset memory.

### Auto store

Auto store selects 6 TV stations automatically and stores each one into preset memory.

If there are not 6 stations with good reception, stations previously stored in memory remain and only the strong stations are stored into memory.

1. Press the [ **BAND** ] button and select the desired TV band (TV1 or TV2).
2. Press and hold the [ **P/A** ] button for 2 seconds or longer. The stations with good reception are stored automatically to the preset channels.

### Preset scan

Preset scan allows the user to view each preset position before it automatically advances to the next preset. This function is useful for searching for a desired TV station in memory.

1. Press the [ **P/A** ] button.
2. When the desired station is found, press the [ **P/A** ] button again to remain tuned to that station.

#### Note:

- Do not press and hold the [ **P/A** ] button for 2 seconds or longer. Doing so will trigger the auto store function and start storing stations into memory.

### Setting the TV area

When you select the TV area (TV reception area), the TV tuner area setting changes.

1. Press and hold the [ **T** ] button for 1 second or longer to switch to the adjustment selection display.
2. Press the [ **<<** ] or [ **>>** ] button to select "**TV AREA**".
3. Press the [ **▶/||** ] button.
4. Press the [ **▲** ] or [ **▼** ] button to select the reception area.
5. Press the [ **▶/||** ] button.
6. Press the [ **T** ] button to return to the previous mode.

### Setting the TV diver

You can change the reception setting for the TV antenna connected to the TV tuner.

1. Press and hold the [ **T** ] button for 1 second or longer to switch to the adjustment selection display.
2. Press the [ **<<** ] or [ **>>** ] button to select "**TV DIVER**".
3. Press the [ **▲** ] button to set to "**DIVR ON**" or press the [ **▼** ] button to set to "**DIVR OFF**".
  - **DIVR ON** : Sets reception emphasizing the visual.
  - **DIVR OFF** : Sets the diver setting to OFF.
4. Press the [ **T** ] button to return to the previous mode.

# 8. IN CASE OF DIFFICULTY

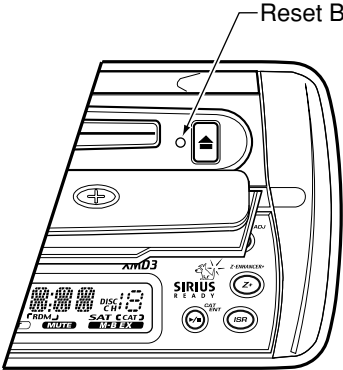
Problem	Cause	Solution
Power does not turn on. (No sound is produced.)	Fuse is blown.	Replace with a fuse of the same amperage. If the fuse blows again, consult your store of purchase.
	Incorrect wiring.	Consult your store of purchase.
Compact disc cannot be loaded.	Another compact disc is already loaded.	Eject the compact disc before loading the new one.
Sound skips or is noisy.	Compact disc is dirty.	Clean the compact disc with a soft cloth.
	Compact disc is heavily scratched or warped.	Replace with a compact disc with no scratches.
Sound is bad directly after power is turned on.	Water droplets may form on the internal lens when the car is parked in a humid place.	Let dry for about 1 hour with the power on.
Nothing happens when buttons are pressed. display is not accurate.	Microprocessor has malfunctioned due to noise, etc.	<p>Turn off the power, then open the [ DOOR ] by up the [ HOOK ] . Press the reset button for about 2 seconds with a thin rod.</p> 

# 9. ERROR DISPLAYS

If an error occurs, one of the following displays is displayed.  
Take the measures described below to eliminate the problem.

	Error Display	Cause	Measure
CD	<b>ERROR 2</b>	A CD is caught inside the CD deck and is not ejected.	This is a failure of CD deck's mechanism and consult your store of purchase.
	<b>ERROR 3</b>	A CD cannot be played due to scratches, etc.	Replace with a non-scratched, non-warped-disc.
	<b>ERROR 6</b>	A CD is loaded upside-down inside the CD deck and does not play.	Eject the disc then reload it properly.
CD changer	<b>ERROR 2</b>	A CD inside the CD changer is not loaded.	This is a failure of CD changer's mechanism and consult your store of purchase.
	<b>ERROR 3</b>	A CD inside the CD changer cannot be played due to scratches, etc.	Replace with a non-scratched, non-warped disc.
	<b>ERROR 6</b>	A CD inside the CD changer cannot be played because it is loaded upside-down.	Eject the disc then reload it properly.
MD changer	<b>ERROR H</b>	Displayed when the temperature in the MD changer is too high and playback has been stopped automatically.	Lower the surrounding temperature and wait for a while to cool off MD changer.
	<b>ERROR 2</b>	An MD inside the MD changer is not loaded.	This is a failure of MD changer's mechanism and consult your store of purchase.
	<b>ERROR 3</b>	An MD inside the MD changer cannot be played due to scratches, etc.	Replace with a non-scratched, non-warped disc.
	<b>ERROR 6</b>	An MD inside the MD changer cannot be played because it is loaded upside-down.	Eject the disc then reload it properly.
		Displayed when a non-recorded MD is loaded in the MD changer.	Load a pre-recorded MD in the MD changer.

If an error display other than the ones described above appears, press the reset button. If the problem persists, turn off the power and consult your store of purchase.



# 10. SPECIFICATIONS

## **FM Tuner**

Frequency Range :

U.S.A : 87.9 MHz to 107.9 MHz

Europe : 87.5 MHz to 108.0 MHz

Australia : 87.0 MHz to 108.0 MHz

Usable Sensitivity : 9 dBf

50dB Quieting Sensitivity : 15 dBf

Alternate Channel Selectivity : 70 dB

Stereo Separation (1 kHz) : 35 dB

Frequency Response ( $\pm 3$  dB) : 30 Hz to 15 kHz

## **AM Tuner**

Frequency Range :

U.S.A : 530 kHz to 1710 kHz

Europe : 531 kHz to 1602 kHz

Australia : 531 kHz to 1629 kHz

Usable Sensitivity : 25  $\mu$ V

## **CD Player**

System : Compact disc digital audio system

Usable Discs : Compact disc

Frequency Response ( $\pm 1$  dB) : 10 Hz to 20 kHz

Signal to Noise Ratio (1 kHz) : 100 dB

Dynamic Range (1 kHz) : 95 dB

Harmonic Distortion : 0.01%

## **Audio**

Maximum Power Output : 208 W (52 W  $\times$  4 ch)

Continuous Average Power Output :

17 W  $\times$  4, into 4  $\Omega$ , 20 Hz to 20 kHz, 1%THD

Bass Control Action (60 Hz) :  $\pm 15$  dB

Treble Control Action (10 kHz) :  $\pm 12$  dB

Line Output Level (CD 1 kHz) : 2 V

## **General**

Power Supply Voltage :

14.4 V DC (10.8 to 15.6 V allowable), negative ground

Current Consumption : Less than 15 A

Speaker Impedance : 4  $\Omega$  (4  $\Omega$  to 8  $\Omega$  allowable)

Weight / Source unit : 3.52 lb. (1.6 kg)

Dimensions / Source unit :

7" (Width)  $\times$  2" (Height)  $\times$  6" (Depth)

[178 (W)  $\times$  50 (H)  $\times$  152 (D) mm]

Escutcheon section :

9" (Width)  $\times$  4" (Height)  $\times$  1-1/2" (Depth)

[232 (W)  $\times$  95 (H)  $\times$  28 (D) mm]

## **Note:**

- Specifications and design are subject to change without notice for further improvement.

